

AKD2G Servo Drive with Safe Motion

Enhancement of the AKD servo drives with Safe Motion technology



AKMH Hygienic
Stainless Steel Motors



AKM™ Servo Motors

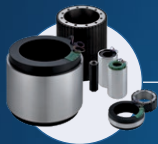

Frameless Brushless
Direct Drive Motors



Cartridge DDR™ Motors



Housed DDR™ Motors

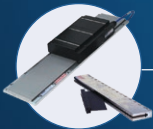

Direct Drive Linear
Motors



Linear Actuators



Multi-Axis Precision
Tables



Optional KSM Safety
Module



Optional PCMM Stand Alone
Drive



AKD2G Servo Drives
with FSOE

KOLLMORGEN®

Because Motion Matters™

Powerful, yet Simple. Integrated Safe Motion Increases Ease-of-Use!

The newest member of the AKD family is our most powerful yet:

The new AKD2G servo drive introduces the Kollmorgen Servo-on-a-Chip: A powerful compute engine that can control 2 axes simultaneously while handling Safe Motion Monitor (an integrated safety solution), and up to 28 I/O. While we were at it, we streamlined the design by optimising the AKD2G for single-cable motors.

Flexible

- One and two axis variants available
- Modular design allows the user to specify only the features needed
- Supports a variety of feedback devices—SFD & HIPERFACE® DSL standard;
- optional feedbacks include EnDat2.2, BiSS 1.0, Analog Sine/Cos encoder, incremental encoder, resolver and more
- Multiple bus choices for system optimization, including EtherCAT® & FSoE, and CANopen®
- SIL-qualified over-voltage, current, and temperature detection provided for added dependability
- Optional Safe Motion Monitor (SMM), SIL3/PLe
- Industry-leading power density for greater flexibility in mounting
- Fits into a 10" deep control panel

Easy to Use

- Plug-and-play compatibility with Kollmorgen controls and motors
- WorkBench GUI, acclaimed for customer experience and usability
- Hybrid Motor-Power connector is optimized for single-cable motors:
 - No adaptors, no D-sub, no splitters
- Cage-clamp spring terminal connectors on I/O allow for fast and easy installation
- Optically-isolated I/O reduces noise, and eliminates need for additional hardware

Fast

- Accommodates changing load conditions immediately:
 - Current loop updates in 1.28 μ s, nearly 50x the speed of our nearest competitors
 - Velocity and position loops lead the market at 62.5 μ s and 250 μ s, respectively
- Servo on a Chip™ includes dual-core ARM™ A9, 800 MHz μ P, 1.5 M gates
- Auto-tuning with a click of a button gets you started quickly
- Wizard-based tuning uses advanced Bode Plot tool to help you efficiently manual-tune when desired
- Fast data acquisition with TCP/IP Ethernet service channel

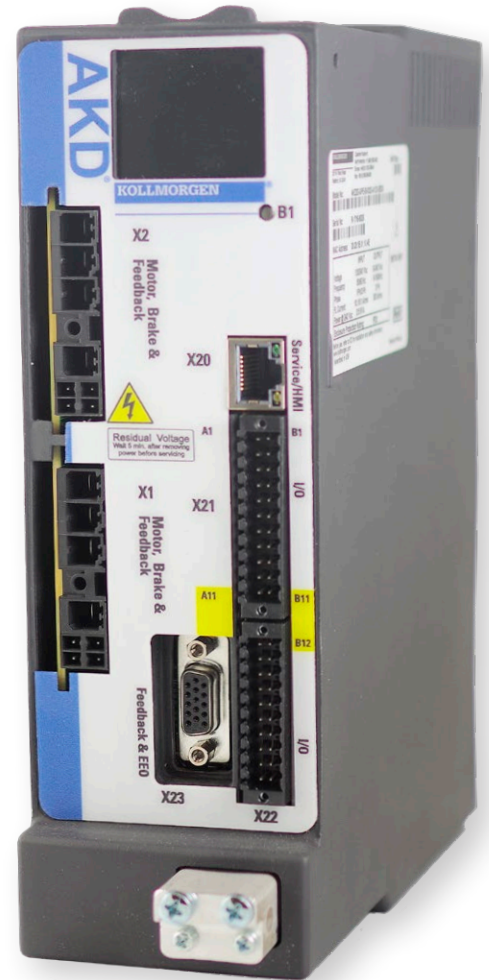

Dual-Axis AKD2G Servo Drive



Kollmorgen WorkBench, the Perfect Companion for AKD2G

Our simple Graphical User Interface (GUI), Kollmorgen WorkBench, is designed to expedite and streamline the user's experience with the AKD[®] servo drive. From easy application wizards and reduced math, to a sleek six-channel scope; the user interface is extremely easy to use. Kollmorgen WorkBench supports intuitive access to the exclusive Performance Servo Tuner (PST) available inside AKD. The patented PST makes auto-tuning the AKD high-performance servo drive with world-class Kollmorgen motors very simple.

User-Friendly Environment

Logical flow, colorful icons and easy access simplify interactions with the AKD servo drive. The folder structure allows for instant identification and easy navigation.

Sleek Six-Channel "Real-Time" Software Oscilloscope

The easy-to-use AKD servo drive interface has a sleek digital oscilloscope that provides a comfortable environment for users to monitor performance.

There are multiple options to share data in the format you prefer at the click of a button.

- Save as an image
- Load to an e-mail
- Print

Data-Sharing

The ease-of-sharing continues in the parameters window. Kollmorgen WorkBench provides the user the easy options of printing or emailing the parameter values at the click of a button.

Application Selection Wizards

Simplifies set-up by allowing use of machine or application-based units. Nip roller and rack and pinion set-ups shown.

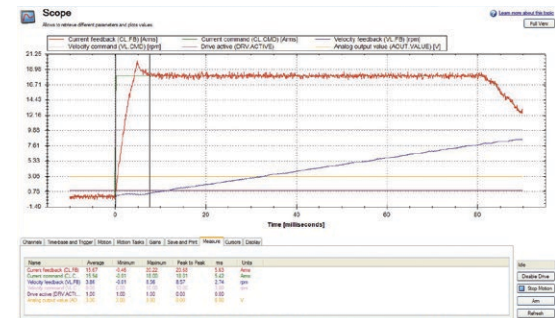
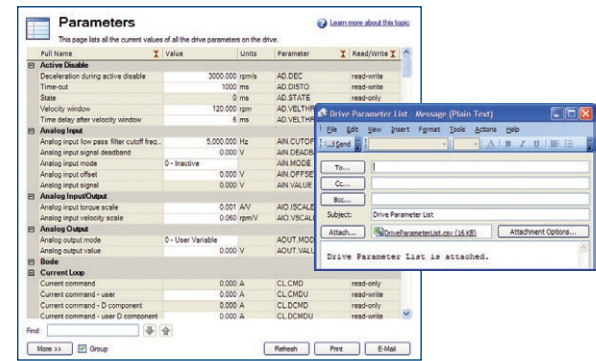

Rack and Pinion Application Selection

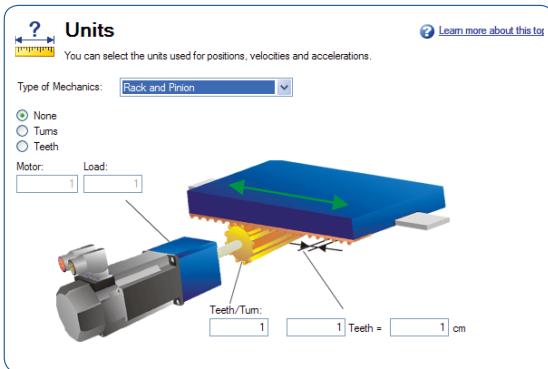

Nip Roller Application Selection

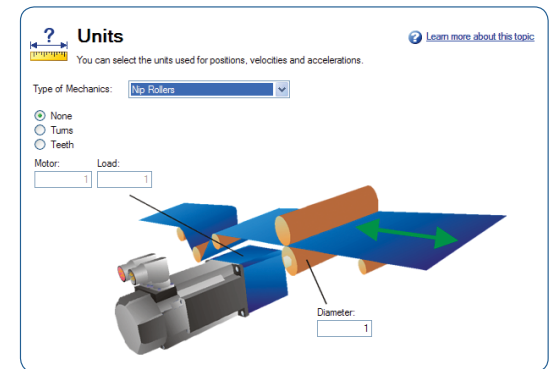

Realize Substantial Productivity Gains with AKD2G's Integrated SafeMotion

Increase Machine Uptime & OEE with Drive-Integrated SafeMotion

Conventional safety technology keeps the operator away from areas with dangerous motion via mechanical guarding, hence the operator has limited access to the operation process.

By contrast, drives with integrated SafeMotion allow user intervention without interrupting the process. The safety logic in the drive controls motion sequences so that no danger can result from them, even as the machine continues to operate.

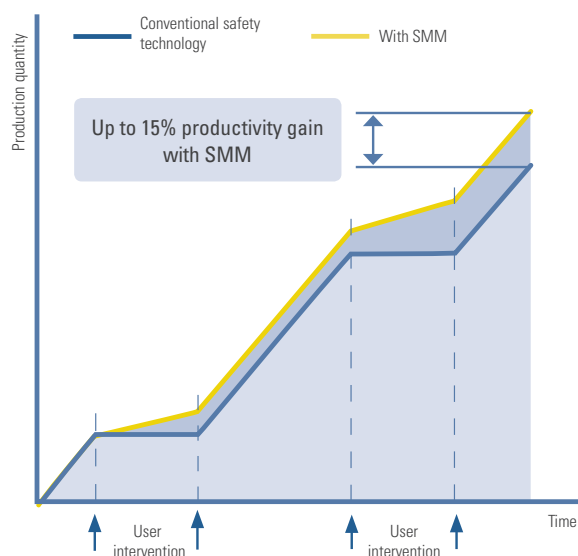

Reduce Cost and Simplify Without Compromise

Plug & Safe – Functional Safety over EtherCAT (FSoE) reduces wiring and simplifies engineering

Drive-integrated FSoE is the core technology of the 3rd-generation of the Kollmorgen SafeMotion solution.

Prior generations of SafeMotion, although better than mechanical guarding, required additional edge devices and complicated hardwiring between them.

3rd-generation SafeMotion reduces component count and wiring, which simplifies the system and reduces cabinet size.

Key benefits of AKD2G FSoE Technology

- Smooth integration with an array of FSoE master devices
- Complies with ETG standard and ETG SafeMotion Profile
- Safe activation via FSoE master with only Ethernet cabling
- Very fast response to safe I/O such as a light curtain
- Safe position transmitted to FSoE master

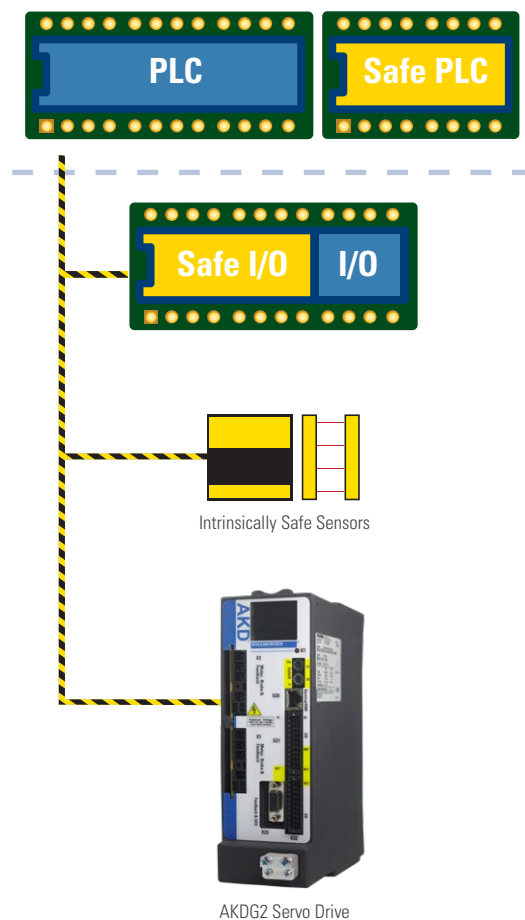

Quickly Integrate AKD2G Into Your Automation System

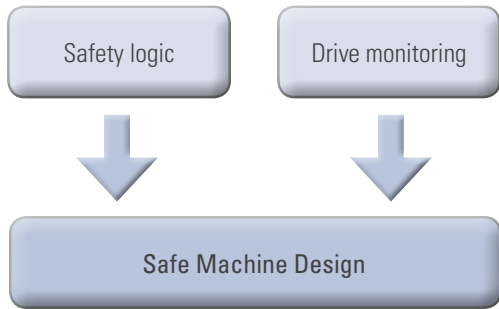

Easy to Use

- WorkBench or FSoE master tool:
 - Easy configuration and troubleshooting
 - Simplified commissioning & troubleshooting
 - Simple field drive replacement

Flexible & Seamless Integration

- Easy connectivity to simple safety relays or to FSoE master
- Standalone safety without additional safety control
- Central SafeMotion parameter storage in the PLC

Innovative SafeMotion

- Single cable technology with optional safe encoder
- Optional Safe EnDAT 2.2 high accuracy e.g. with linear feedback
- Quick (~ms) response to critical events
- Extended safety functions like Safe Dynamic Brake (SDB) and Safe Brake Test (SBT)

Extensive Safety Functions for Safe Motion

STO (Safe Torque Off)

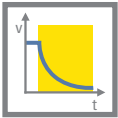

STO safely interrupts the power supply to the motor in the servo drive. The motor becomes torque-free.

SBC/SBT (Safe Brake Control & Safe Brake Test)

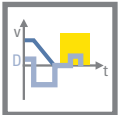

Test function for external brakes and the internal motor holding brake: Far simpler than testing brake from PLC/PAC

SS2¹ (Safe Stop 2)



The drive is brought to a standstill by controlled regenerative braking and subsequently remains in controlled standstill. SS2 terminates in SOS

SLS¹ (Safe Limited Speed)

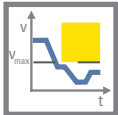

Monitors that the drive observes a defined speed limit. In the event of an error, SS1 is triggered.²

SLP¹ (Safe Limited Position)

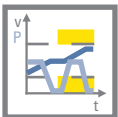

Monitors the absolute position of the drive. If the limit value is reached or the brake torque is too low to keep the drive within the limit value, SS1 is triggered.²

SS1 (Safe Stop 1)

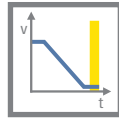

The drive is brought to a standstill by controlled braking. After a specified time the power supply to the motor is safely interrupted and the motor becomes torque-free.

SOS² (Safe Operating Stop)

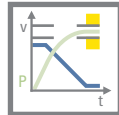

Monitors the stop position reached and triggers SS1 in the event of deviations beyond the specified limits.

SDI¹ (Safe Direction)

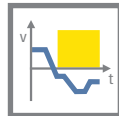

The SDI function ensures that the drive can only move in a defined direction. In the event of an error, SS1 is triggered.

SSR¹ (Safe Speed Range)

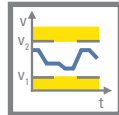

Monitors that the drive observes a defined speed limit. In the event of an error, SS1 is triggered.

SLI¹ (Safe Limited Increments)

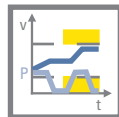

Monitors the relative position of the drive with respect to the current position when activating the SLI function. SS1 is triggered when the prescribed limit value is reached.

¹ Requires "Safe" feedback device

² SS1 if *faulted* is the default setting. Users can easily configure this or other actions in WorkBench.

AKD[®] 2G Means Unparalleled Connectivity

Base Model:

The base model of Kollmorgen's AKD2G includes all of the performance described on page 2, and is optimized to interface to a single-connector motor with Kollmorgen's Smart Feedback or HiPerFace DSL. It also offers 16 I/O, 160x128-pixel graphical display, removable SD card, and your choice of motionbusses.

Extended I/O variant

The extended I/O variant offers everything on the base model, plus I/O expansion.

This I/O expansion includes the 15-pin D-sub for legacy feedbacks or dual-loop operation; it also includes an additional 12 I/O for a total of 28 I/O. The options fit in the same package as the base model.

Safe Motion Monitor (SMM)

The I/O expansion is included in the Safety options. The SMM converts some of the I/O into "Safe" I/O, and allows the drive to interface safely to an FSoE master. Again, these options fit in the same package as the base model.



Single-Axis AKD2G 480 V AC
(shown with optional
feedback and I/O expansion)

Dual-Axis AKD2G 240 V AC
(Shown with optional SMM)

Safety over
EtherCAT

ERC CANopen[®] CE

UL
LISTED

ISO
International
Organization for
Standardization

RoHS

General Specifications

120/240 Vac	Continuous Current	Peak Current	Typical Shaft Power	Internal Regen		Height	Width	Depth	Depth w/ cable bend radius
	(Arms)	(Arms)	(kW)	(W)	(Ω)	mm	mm	mm	mm
AKD2G-6V03S	3	9	1	100	15	233	75	180	225
AKD2G-6V06S	6	18	2						
AKD2G-6V12S	12	30	4						
AKD2G-6V03D	3 & 3	9 & 9	1 & 1						
AKD2G-6V06D	6 & 6	18 & 18	2 & 2						

240/480 Vac	Continuous Current	Peak Current	Typical Shaft Power	Internal Regen		Height	Width	Depth	Depth w/ cable bend radius
	(Arms)	(Arms)	(kW)	(W)	(Ω)	mm	mm	mm	mm
AKD2G-7V03S	3	9	2	100	33	270	75	180	225
AKD2G-7V06S	6	18	4						
AKD2G-7V12S	12	30	8						
AKD2G-7V03D	3 & 3	9 & 9	2 & 2						
AKD2G-7V06D	6 & 6	18 & 18	4 & 4						

AKD[®] 2G Drive Connector Layout

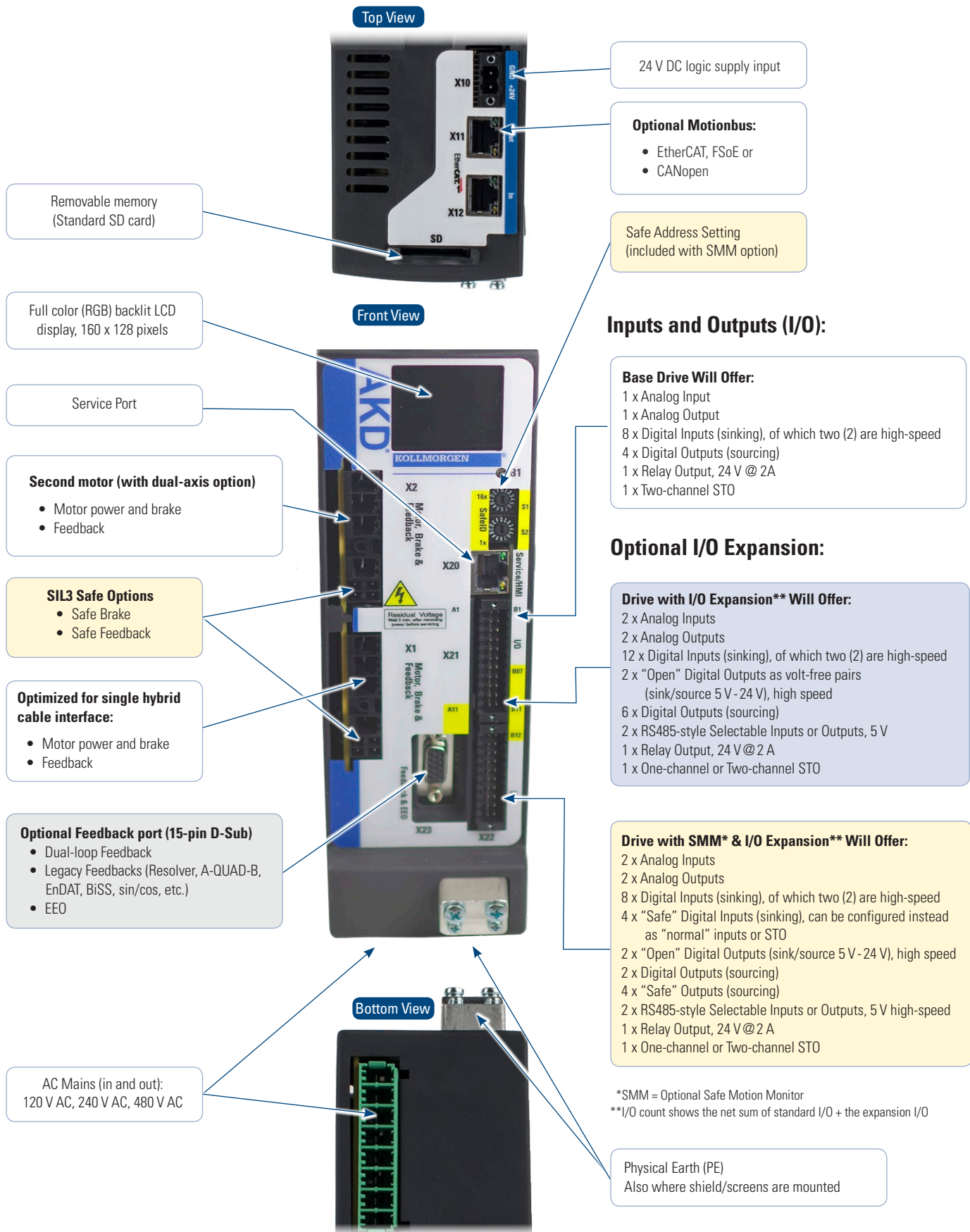

About Kollmorgen

Kollmorgen is a leading provider of motion systems and components for machine builders. Through world-class knowledge in motion, industry-leading quality and deep expertise in linking and integrating standard and custom products. Kollmorgen delivers breakthrough solutions that are unmatched in performance, reliability and ease-of-use, giving machine builders an irrefutable marketplace advantage.

For assistance with your application needs visit www.kollmorgen.com for a global contact list.

- Application Centers
- Global Design & Manufacturing
- Global Manufacturing



KOLLMORGEN Europe GmbH
Pempelfurtstraße 1
40880 Ratingen
Germany
Phone: +49 (0) 2102 9394 0
Fax: +49 (0) 2102 9394 3155

KOLLMORGEN®

Because Motion Matters™